

MYTHO

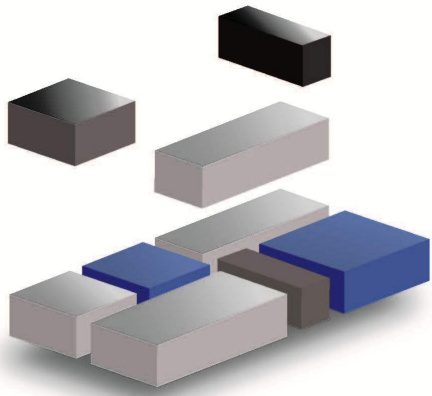

B.F INDUSTRIES

Tecnologia evoluta a servizio dell'uomo



Il sistema Mytho Mytho system



- 🇮🇹 Grazie al minimo ingombro mi trasportano facilmente con costi ridotti e sto ovunque.
- 🇬🇧 Thanks to my compact size I can be shipped economically and I fit anywhere.
- 🇫🇷 Grâce au moindre encombrement, il se transporte facilement avec des coûts réduits et il peut être positionné partout.
- 🇩🇪 Einfach zu transportieren und in jeder Stelle zu platzieren dank der kompakten Bauweise.
- 🇪🇸 Gracias al mínimo espacio, facilita el transporte con un reducido coste.



I vecchi sistemi Old systems



- 🇮🇹 I sistemi tradizionali sono più ingombranti.
- 🇬🇧 Traditional systems take up more space.
- 🇫🇷 Les systèmes traditionnels sont plus encombrants.
- 🇩🇪 Die konventionelle Systeme brauchen mehr Platz.
- 🇪🇸 Los sistemas tradicionales son más voluminosos.

- 🇮🇹 Non necessita di manutenzione.
- 🇬🇧 I don't need maintenance.
- 🇫🇷 Il ne requiert aucun entretien.
- 🇩🇪 Reduzierte Wartungskosten.
- 🇪🇸 No necesita de mantenimiento.



- 🇮🇹 I sistemi tradizionali necessitano di manutenzione e usano meccanismi che vanno regolati e ingrassati.
- 🇬🇧 Traditional systems need maintenance and use mechanisms that require adjusting and lubricating.
- 🇫🇷 Les systèmes traditionnels nécessitent un entretien et ils utilisent des mécanismes qui doivent être graissés et réglés.
- 🇩🇪 Die konventionelle Systeme brauchen regelmäßige Wartung, Einstellung und Schmierung.
- 🇪🇸 Los sistemas tradicionales necesitan de mantenimiento y usan mecanismos guiados y engrasados.

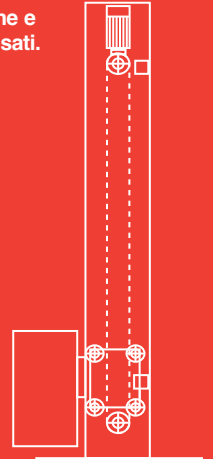

- 🇮🇹 Inserisco il film estensibile con facilità e ne consumo poco.
- 🇬🇧 I easily insert stretch film and I use it economically.
- 🇫🇷 Facilité de passage du film en sécurité et consommation réduite.
- 🇩🇪 Schnelle Einführungssystem und sparsame Verbrauch von Stretchfolien.
- 🇪🇸 Introducción del film extensible con facilidad y reducido tiempo.







- 🇮🇹 I sistemi tradizionali sono pericolosi, poco rapidi e dispendiosi.
- 🇬🇧 Traditional systems are dangerous, slow and costly.
- 🇫🇷 Les systèmes traditionnels sont dangereux, plus lents et plus onéreux.
- 🇩🇪 Die konventionelle Systeme sind gefährlich, langsam und teuer.
- 🇪🇸 Los sistemas tradicionales son más peligrosos, poco rápidos y costosos.

- 🇮🇹 Non necessita di installazione.
- 🇬🇧 I don't need to be installed.
- 🇫🇷 Il ne nécessite aucune installation.
- 🇩🇪 Reduzierte Inbetriebnahmekosten.
- 🇪🇸 No necesita de instalación.



- 🇮🇹 Nei sistemi tradizionali l'albero con catena va montato durante installazione.
- 🇬🇧 In traditional systems, the mast with chain must be mounted during installation.
- 🇫🇷 Sur les systèmes traditionnels le mat doit être monté.
- 🇩🇪 In der konventionellen Systeme der Mast mit Kette wird bei Inbetriebnahme aufgestellt.
- 🇪🇸 En los sistemas tradicionales el eje con cadena se monta durante la instalación.

MYTHO

-  Tavola rotante di nuova generazione per avvolgere carichi palletizzati di qualsiasi forma e peso con film estensibile anche macroforato.
-  Stretchwickler der neuen Generation zum Wickeln von Ladungen unterschiedliche Formen und Gewichte mit Stretchfolien oder gelochte Stretchfolien.
-  New design turntable for wrapping palletised loads of any shape and weight with stretchable film, including macro-holed film.
-  Mesa rotante de nueva generación para envolver cargas paletizadas de cualquier forma y peso, con film extensible y macro perforado.
-  Table tournante de dernière génération pour filmer les charges palettisées avec du film étirable plein ou macro perforé.

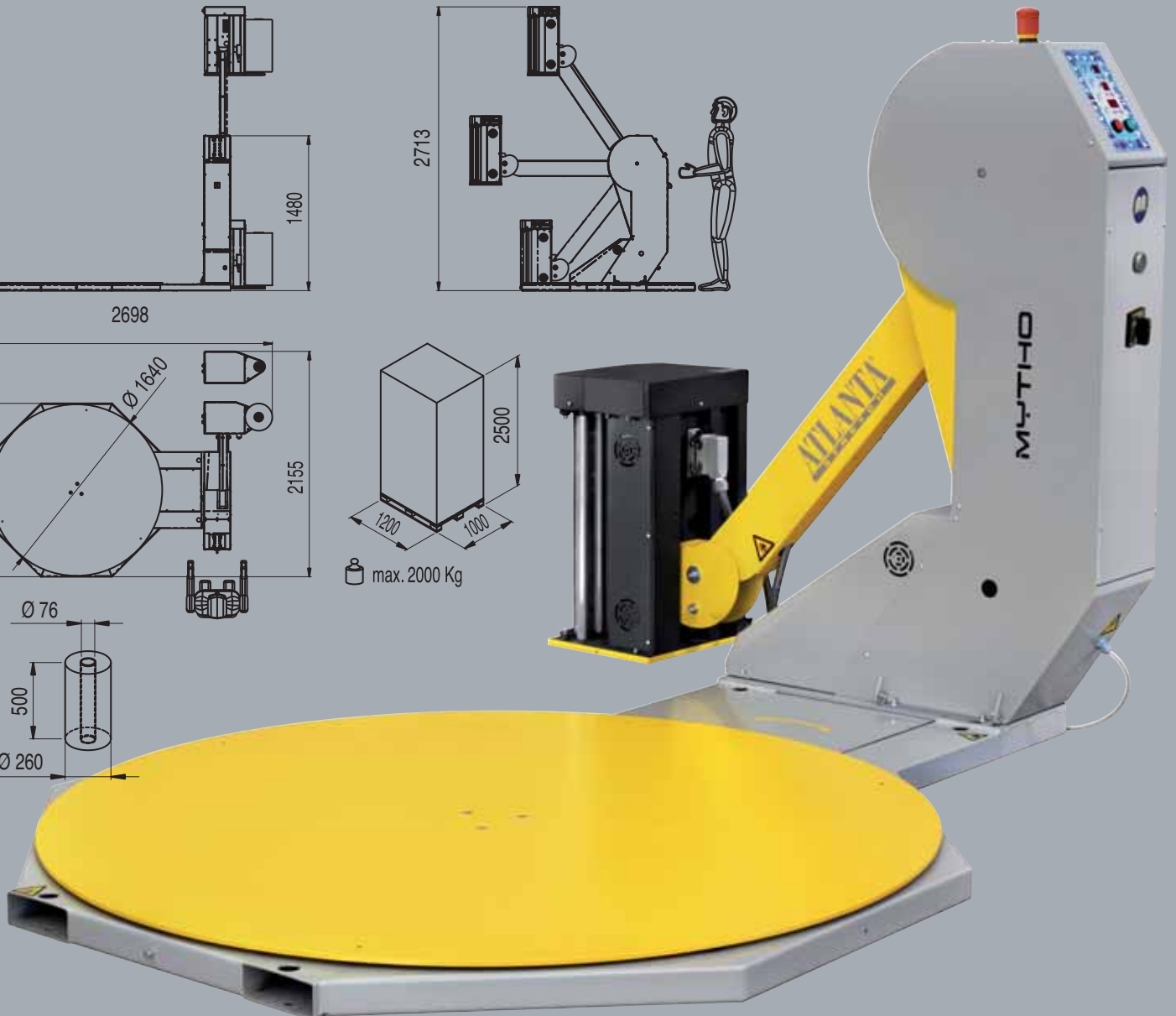
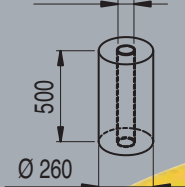
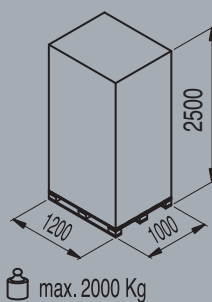
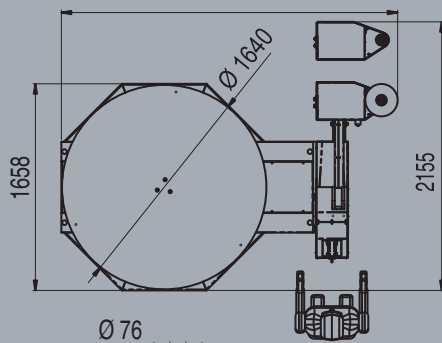
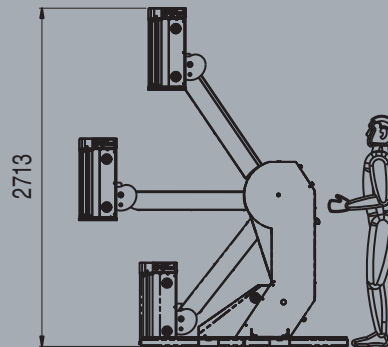
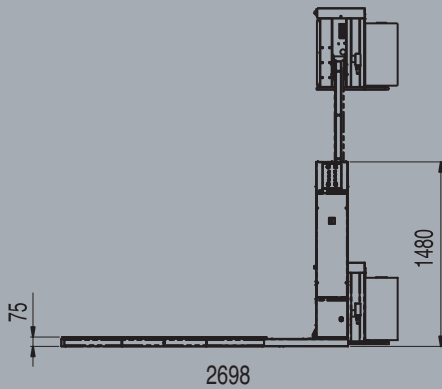
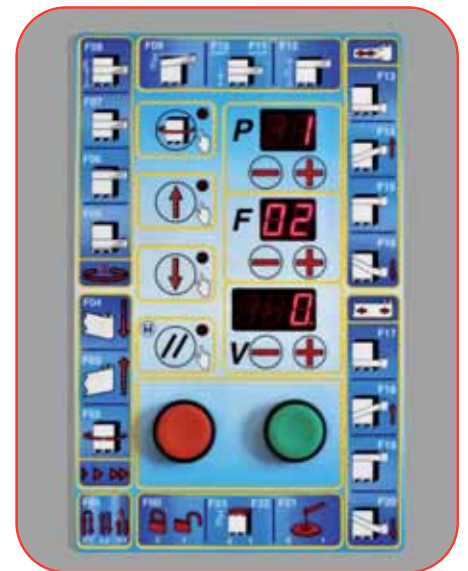

MYTHO TP

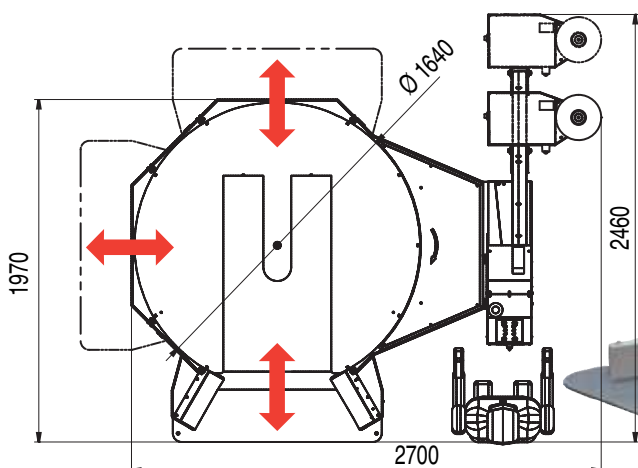

🇮🇹 Versione transpallet.

🇬🇧 Transpallet version.

🇫🇷 Version transpalette.

🇩🇪 Ausführung Transpallet.

🇪🇸 Version transpaleta.

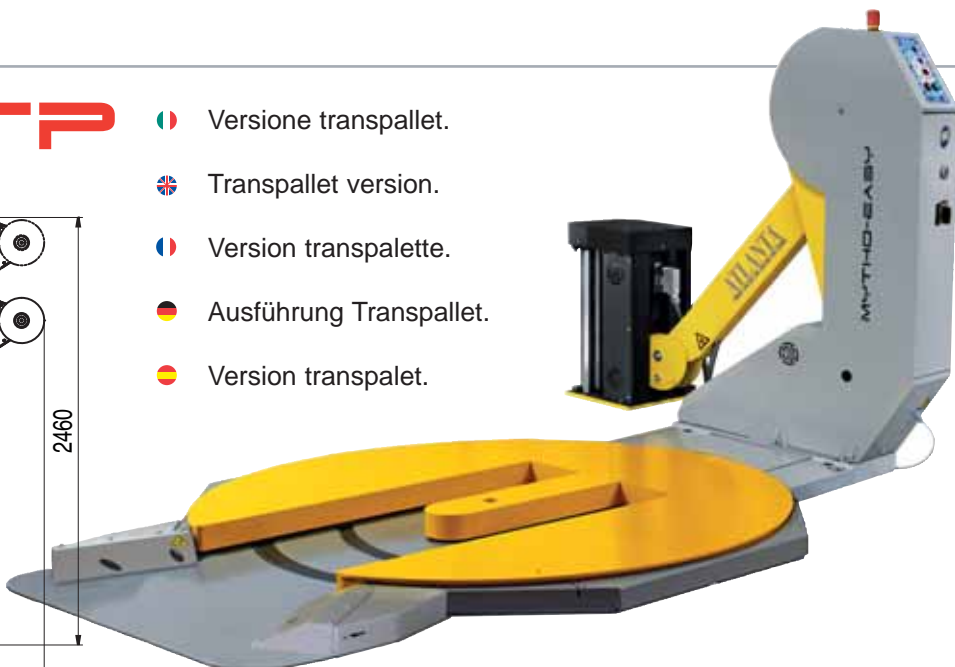

FM

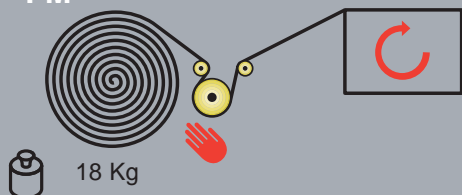

18 Kg

🇮🇹 Freno meccanico regolabile manualmente

🇬🇧 Mechanical brake manually adjustable.

🇫🇷 Frein mécanique sur rouleau de détour ajustable manuellement.

🇩🇪 Mechanische Bremse auf Umlenkwalze.

🇪🇸 Fricción mecánica regulable manualmente.

FE

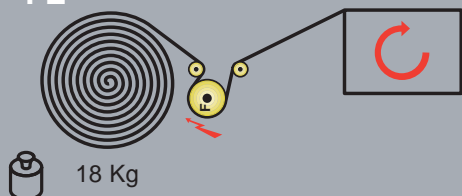

18 Kg

🇮🇹 Frizione elettromagnetica regolabile da pannello comandi.

🇬🇧 Electromagnetic friction adjustable from control panel.

🇫🇷 Frein électro magnétique sur rouleau de détour ajustable au pupitre de commandes.

🇩🇪 Elektromagnetische Bremse auf

Umlenkwalze vom Bedienpult einstellbar.

🇪🇸 Fricción electromagnética regulable desde el panel de comandos.

PRS POWER ROLLER STRETCH

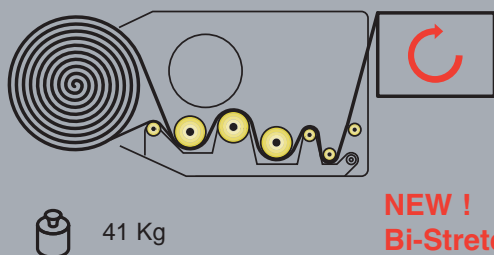

41 Kg

**NEW !
Bi-Stretch**

🇮🇹 Sistema di prestiro motorizzato a 3 rulli comandato elettronicamente con rapporti intercambiabili: 150 - 200 - 250 %.

🇬🇧 Motorized pre-stretch system with 3 driven rollers electronically controlled with interchangeable ratios: 150 - 200 - 250%

🇫🇷 Système de pré-étirage à 3 rouleaux motorisés avec asservissement électronique et rapports facilement interchangeables 150 - 200 - 250%

🇩🇪 Angetriebener Vordehnssystem mit 3 Vordehnrollen, elektronisch gesteuert mit leicht

wechselbarer Zahnradsätzen: 150 - 200 - 250%.

🇪🇸 Sistema de prestiro motorizado con 3 rodillos, comandado electrónicamente con desarrollos intercambiables: 150 - 200 - 250%.

PS POWER STRETCH

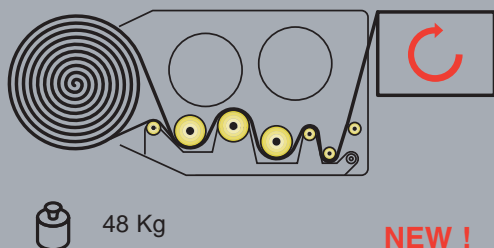

48 Kg

**NEW !
Bi-Stretch**

🇮🇹 Sistema di prestiro motorizzato a 3 rulli con 2 motori e variazione continua da 120 a 350% regolabile da quadro comandi.

🇬🇧 Motorized pre-stretch system with 3 driven rollers and 2 motors adjustable between 120 to 350% from control panel.

🇫🇷 Système de pré-étirage à 3 rouleaux motorisés avec asservissement électronique et rapport ajustable au pupitre de commandes de 120 à 350 % par 2 moteurs.

🇩🇪 Angetriebener Vordehnssystem mit 3 Vordehnrollen und 2 Motoren, stufenlos

regelbare Werte zwischen 120 und 350% von Bedienpult.

🇪🇸 Sistema de prestiro motorizado con 3 rodillos y 2 motores, regulable da 120 a 350% desde el panel de comandos.

MYTHO EASY

NEW

- Con Mytho-Easy (facile da usare), si completa la gamma di macchine, questa versione si caratterizza per le funzioni semplificate. Pannello di controllo multifunzione programmabile.
- The easy-to-use Mytho-Easy completes our range of machines; this version features simplified operation. Multifunction programmable control panel.
- Mytho-Easy (utilisation facile) se caractérise pour l'utilisation et l'application de film pré-étiré et par ses fonctions simples mais complètes.

Panneau de contrôle multifonction programmable.

- Mytho-Easy (Einfach zum Bedienen) ergänzt die Baureihe der Stretchwickler, das Merkmal dieses Modell ist die Vereinfachung der Funktionen. Multifunktion programmierbare Systemsteuerung.
- Con Mytho-Easy (facil da usar), se completa la gama de maquinas, esta versión se caracteriza por las funciones simplificadas. Panel de control programable multifunción.



Parametri facilmente regolabili tramite pannello.

- Velocità di rotazione tavola.
- Salita e discesa carrello.
- Programmazione separata giri alti e bassi.
- Fotocellula lettura altezza pallet.
- Ciclo salita / salita e discesa.
- Ciclo mettifoglio.
- Cicli manuali: Rotazione tavola, Salita e discesa carrello portabobina.

Parameters easily adjustable from the panel.

- Table rotation speed.
- Carriage ascent and descent.
- Separate programming for high and low rpm.
- Pallet height photoelectric cell reading.
- Ascent / Ascent and Descent cycle.
- Sheet placement cycle.
- Manual cycles: Table rotation, Roll carriage ascent and descent.

Paramètres ajustables au pupitre.

- Vitesse de rotation de la table
- Vitesse de déplacement du chariot
- Tours droits haut et bas séparés
- Débordement supérieur du film
- Cycle montée et descente
- Cycle montée et descente seule
- Cycle dépose de coiffe
- Cycles manuels: Rotation table Montée/arrêt du chariot Descente /arrêt du chariot.



- Rampa di carico.
- Ladungsrampe.
- Loading ramp.
- Rampa de carga.
- Rampe.

Einstellbare Parameter von Bedienungstafel.





- Stufenlos regelbare Drehtellergeschwindigkeit.
- Stufenlos regelbare Hubschlittengeschwindigkeit.
- Einstellbare Anzahl für Fuß- und Kopfwicklungen.
- Fotozelle zur selbständigen Höhenabfrage.
- Kreuzspiral und Spiral.
- Regendichtprogramm.
- Manueller Zyklusablauf: Drehtellerdrehung. Hubschlitten Auf- und Abwärts.

Parámetros de fácil regulación mediante panel.

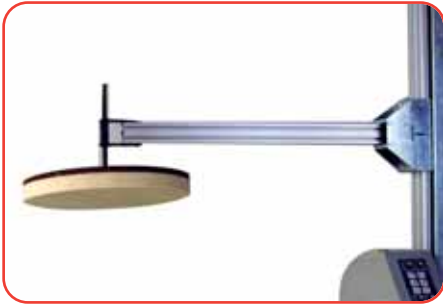



- Velocidad de rotación de la mesa.
- Subida y bajada carro.
- Programacion separada de vueltas altas y bajas.
- Fotocelula lectura altura palet.
- Ciclo subida/subida y bajada.
- Ciclo metefolio.
- Ciclos manuales: Rotacion mesa. Subida y bajada carro porta bobina.









-  Pressore tenuta pallet.
-  Pallet holder presser.
-  Plateau stabilisateur de charge.
-  Palettendruckhalter.
-  Prensor retención palet.







-  Colonna per carichi fino a 3300 mm.
-  Mast for loads up to 3300 mm high.
-  Colonne pour charges jusqu'à 3300 mm.
-  Mast für Ladungen bis 3300 mm hoch.
-  Columna para cargas de hasta 3300 mm.







-  Rulliera non motorizzata.
-  Non-motorized roller conveyor.
-  Non-motorisés à rouleaux.
-  Nicht-Motorisierte Rollenbahn.
-  Rodillos no motorizados.







-  Sistema di pesatura integrato.
-  Integrated weighing systems.
-  Pesage intégré.
-  Integrierte Waagesysteme.
-  Sistema integrado de pesaje.







-  Sistema d'imballo per porte e finestre.
-  Wrapping System for doors and windows.
-  Système d'emballage pour portes et fenêtres.
-  Wickelsysteme für Fenster und Türen.
-  Sistema de embalaje para puertas y ventanas.



-  Sistema di taglio automatico del film a fine ciclo.
-  Automatic Film cutting device at cycle end.
-  Coupe automatique du film.
-  Automatische Folienschneidvorrichtung am Zyklusende.
-  Sistema automático de corte film con fin de ciclo.



-  Controllo peso film.
-  Film weight check.
-  Calcul poids de film.
-  Kontrolle Foliengewicht.
-  Control peso film.

ON REQUEST, INOX OR FREEZER (-30°) VERSIONS.

Dati Tecnici

	MYTHO/MYTHO EASY	MYTHO/MYTHO EASY - TP
Potenza totale installata	1.00 Kw	1.00 Kw
Tensione alimentazione standard	230V monofase - 50/60 Hz - 6A	230V monofase - 50/60 Hz - 6A
Protezione impianto elettrico e motori	IP 54	IP 54
Dimensione max pallet	1000 x 1200 mm	1000 x 1200 mm
Altezza std pallet	2500 mm	2500 mm
Portata max	2000 Kg	1200 Kg
Diametro tavola	1640 mm	1640 mm

Technical Characteristics

	MYTHO/MYTHO EASY	MYTHO/MYTHO EASY - TP
Total installed power	1.00 Kw	1.00 Kw
Standard input voltage	230V mono-phase - 50/60 Hz - 6A	230V mono-phase - 50/60 Hz - 6A
Electrical system and motors protection	IP 54	IP 54
Max pallet dimensions	1000 x 1200 mm	1000 x 1200 mm
Standard pallet height	2500 mm	2500 mm
Max capacity	2000 Kg	1200 Kg
Table diameter	1640 mm	1640 mm

Données Techniques

	MYTHO/MYTHO EASY	MYTHO/MYTHO EASY - TP
Puissance totale installée	1.00 Kw	1.00 Kw
Tension alimentation standard	230V mono-phase - 50/60 Hz - 6A	230V mono-phase - 50/60 Hz - 6A
Protection installation électrique et moteurs	IP 54	IP 54
Dimensions maximum palette	1000 x 1200 mm	1000 x 1200 mm
Hauteur standard palette	2500 mm	2500 mm
Portée maximum	2000 Kg	1200 Kg
Diamètre de la table	1640 mm	1640 mm

Technische Daten

	MYTHO/MYTHO EASY	MYTHO/MYTHO EASY - TP
Gesamte Leistung	1.00 Kw	1.00 Kw
Anschluss-Spannung	230V mono-phase - 50/60 Hz - 6A	230V mono-phase - 50/60 Hz - 6A
Elektroanlage und Motore Schutzart	IP 54	IP 54
Max. Palettenabmessung	1000 x 1200 mm	1000 x 1200 mm
Max. Standard Wickelhöhe	2500 mm	2500 mm
Max. Ladungsgewicht	2000 Kg	1200 Kg
Drehteller Durchmesser	1640 mm	1640 mm

Datos Técnicos

	MYTHO/MYTHO EASY	MYTHO/MYTHO EASY - TP
Potencia total instalada	1.00 Kw	1.00 Kw
Tension de alimentacion estandar	230V mono-phase - 50/60 Hz - 6A	230V mono-phase - 50/60 Hz - 6A
Proteccion montaje electrico y motores	IP 54	IP 54
Dimension max palet	1000 x 1200 mm	1000 x 1200 mm
Altura estandar palet	2500 mm	2500 mm
Peso max	2000 Kg	1200 Kg
Diametro mesa	1640 mm	1640 mm

Synthesi



SFERA



MYTHO-A

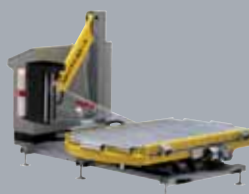

Revolution



OMEGA

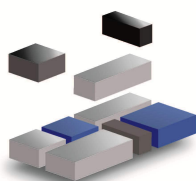

B.F. INDUSTRIES

37 Impasse du Petit Prince

69124 Colombier Saugnieu

Tél:04 78 32 66 70 Fax:04 72 93 23 20

Contact@bf-industries.fr / www.bf-industries.fr