

**SYNTHESI**

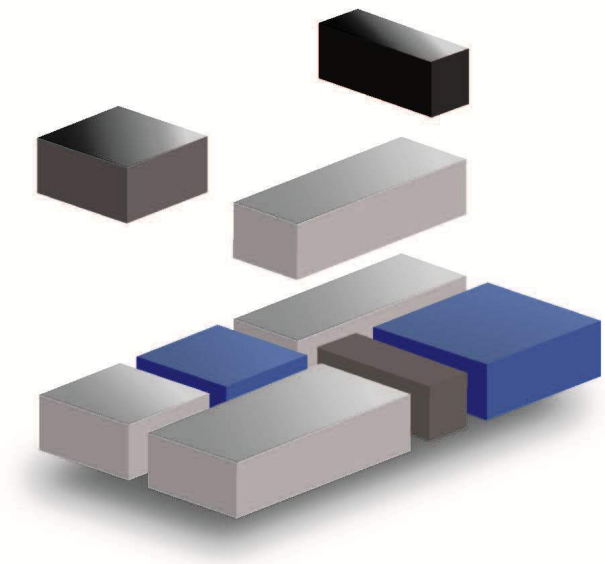



**B.F INDUSTRIES**



# SYNTHEsi

- Synthesi si caratterizza per l'utilizzo e l'applicazione del film estensibile già prestirato e per le sue funzioni semplificate.
- Synthesi wird durch den Gebrauch von Vorgedehnter Stretchfolien und das Bedienpult mit einfacher Funktionen gekennzeichnet.
- Synthesi is characterised by the use and application of already pre-stretch film and its simplified functions.
- Synthesi se caracteriza por la utilización y aplicación de film pre-estirado y por su simplificación de funciones.
- Synthési se caractérise pour l'utilisation et l'application de film pré-étiré et par ses fonctions simples mais complètes.

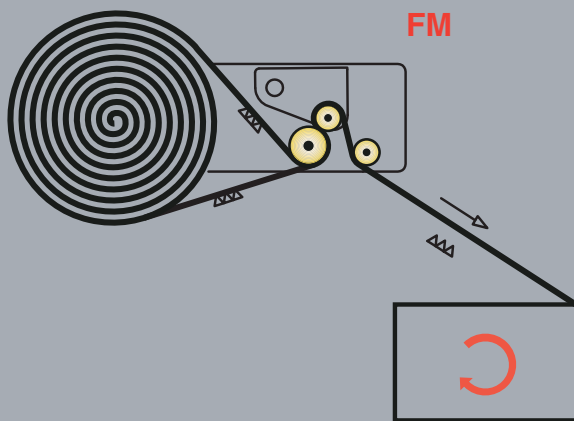
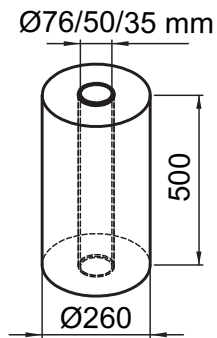

- Frizione meccanica regolabile manualmente.
- Mechanical friction manually adjustable.
- Frein mécanique Réglage manuel.
- Mechanische Bremse auf Umlenkwalze.
- Fricción mecanica regulable manuamente.





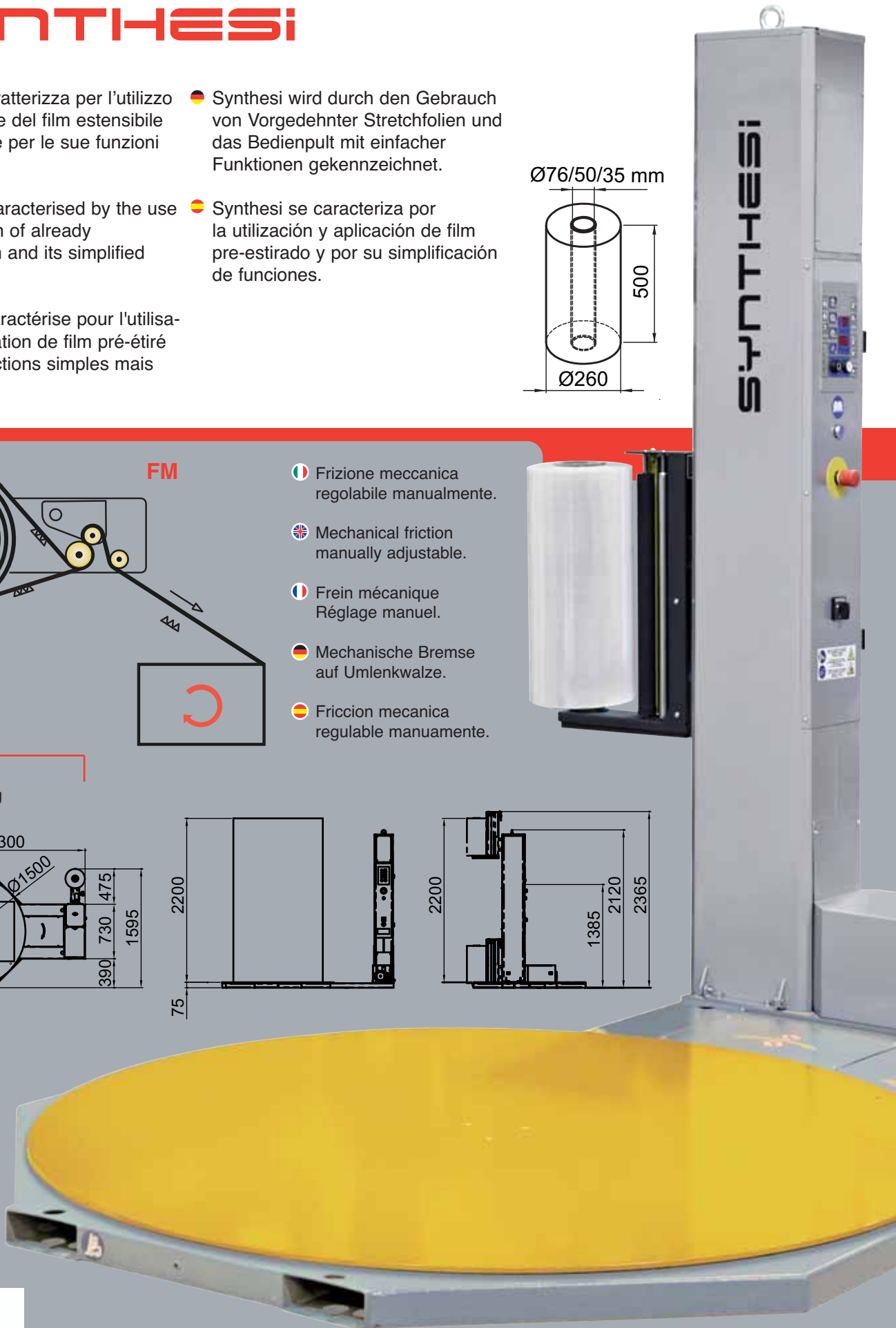
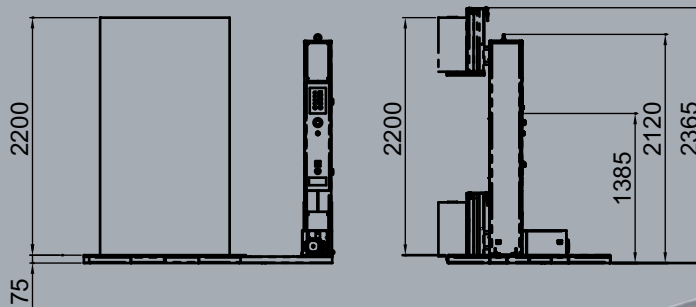
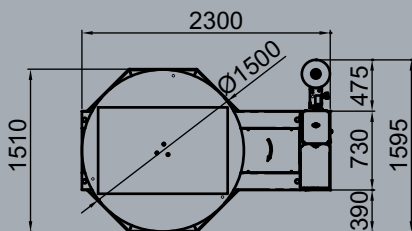

350 Kg

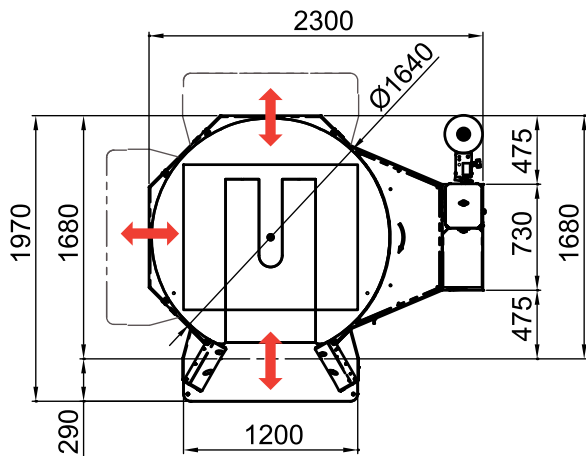





# SYNTHESI TP

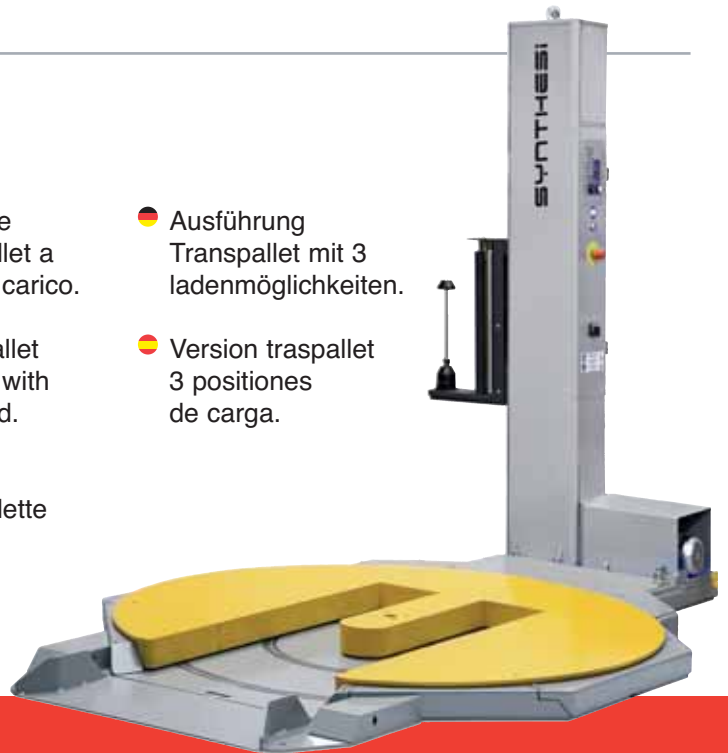

-  Versione transpallet a 3 vie di carico.
-  Ausführung Transpallet mit 3 ladenmöglichkeiten.
-  Transpallet version with 3 in feed.
-  Version traspallet 3 posiciones de carga.
-  Version transpalette 3 voies.



NEW

-  Pannello di controllo a multifunzione programmabile.
-  Multifunction programmable control panel.
-  Panneau de contrôle multifonction programmable.
-  Multifunktion programmierbare Systemsteuerung.
-  Panel de control programable multifunción.

-  **Parametri facilmente regolabili tramite pannello.**
  - Velocità di rotazione tavola.
  - Velocità salita e discesa carrello regolabili separatamente.
  - Programmazione separata giri alti e bassi.
  - Fotocellula lettura altezza pallet.
  - Avvolgimento con esclusione fotocellula (Altimetro)
  - Ciclo salita / salita e discesa.
  - Ciclo mettifoglio.
  - Cicli manuali: Rotazione tavola, Salita e discesa carrello portabobina.

-  **Parameters easily adjustable from the panel.**
  - Table rotation speed.
  - Independently adjustable upwards and downwards carriage speeds.
  - Separate programming for high and low rpm.
  - Pallet height photoelectric cell reading.
  - Wrapping cycles with altimeter (Without photocell).
  - Ascent / Ascent and Descent cycle.
  - Sheet placement cycle.
  - Manual cycles: Table rotation, Roll carriage ascent and descent.

-  **Paramètres ajustables au pupitre**
  - Vitesse de rotation de la table.
  - Vitesse montée et descente chariot réglable séparément.
  - Tours droits haut et bas séparés.
  - Débordement supérieur du film.
  - Cycle banderolage avec altimetre (sans photocellule).
  - Cycle montée et descente.
  - Cycle montée et descente seule.

- Cycle dépose de coiffe.
- Cycles manuels: Rotation table Montée/arrêt du chariot Descente /arrêt du chariot.

-  **Einstellbare Parameter von Bedienungstafel:**
  - Stufenlos regelbare Drehtellergeschwindigkeit.
  - Regelbare Hubschlittengeschwindigkeiten. Auf- und Abwärts getrennt einstellbar.
  - Einstellbare Anzahl für Fuß- und Kopfwicklungen.
  - Fotozelle zur selbständigen Höhenabfrage.
  - Wickelprogramme mit Höhenmesser (Ohne Fotozelle).
  - Kreuzspiral und Spiral.
  - Regendichtprogramm
  - Manueller Zyklusablauf: Drehtellerdrehung. Hubschleifen Auf- und Abwärts.

-  **Parámetros fácilmente regulables mediante panel.**
  - Velocidad de rotacion mesa.
  - Velocidad subida y bajada carro regulable por separado.
  - Programacion separada de vueltas altas y baja.
  - Fotocelula lectura altura palet.
  - Envolvimiento con exclusión de la fotocelula (Altimetro)
  - Ciclo subida / subida y bajada.
  - Ciclo metefolio.
  - Ciclos manuales: Rotacion mesa. Subida y bajada carro porta bobina.



B.F. INDUSTRIES

**Dati Tecnici****SYNTHESE****SYNTHESE TP**

Potenza totale installata	0.85 Kw	0.85 Kw
Tensione alimentazione standard	230V monofase - 50/60 Hz	230V monofase - 50/60 Hz
Protezione impianto elettrico e motori	IP 54	IP 54
Dimensione max pallet	800 x 1200 mm	1000 x 1200 mm
Altezza std pallet	2200 mm	2200 mm
Portata max	1500 Kg	1200 Kg
Diametro tavola	1500 mm	1640 mm

**Technical Characteristics****SYNTHESE****SYNTHESE TP**

Total installed power	0.85 Kw	0.85 Kw
Standard input voltage	230V mono-phase - 50/60 Hz	230V mono-phase - 50/60 Hz
Electrical system and motors protection	IP 54	IP 54
Max pallet dimensions	800 x 1200 mm	1000 x 1200 mm
Standard pallet height	2200 mm	2200 mm
Max capacity	1500 Kg	1200 Kg
Table diameter	1500 mm	1640 mm

**Données Techniques****SYNTHESE****SYNTHESE TP**

Puissance totale installée	0.85 Kw	0.85 Kw
Tension alimentation standard	230V mono-phase - 50/60 Hz	230V mono-phase - 50/60 Hz
Protection installation électrique et moteurs	IP 54	IP 54
Dimensions maximum palette	800 x 1200 mm	1000 x 1200 mm
Hauteur standard palette	2200 mm	2200 mm
Portée maximum	1500 Kg	1200 Kg
Diamètre de la table	1500 mm	1640 mm

**Technische Daten****SYNTHESE****SYNTHESE TP**

Gesamte Leistung	0.85 Kw	0.85 Kw
Anschluss-Spannung	230V mono-phase - 50/60 Hz	230V mono-phase - 50/60 Hz
Elektroanlage und Motore Schutzart	IP 54	IP 54
Max. Palettenabmessung	800 x 1200 mm	1000 x 1200 mm
Max. Standard Wickelhöhe	2200 mm	2200 mm
Max. Ladungsgewicht	1500 Kg	1200 Kg
Drehteller Durchmesser	1500 mm	1640 mm

**Datos Técnicos****SYNTHESE****SYNTHESE TP**

Potencia total instalada	0.85 Kw	0.85 Kw
Tension de alimentacion estandar	230V mono-phase - 50/60 Hz	230V mono-phase - 50/60 Hz
Proteccion montaje electrico y motores	IP 54	IP 54
Dimension max palet	800 x 1200 mm	1000 x 1200 mm
Altura estandar palet	2200 mm	2200 mm
Peso max	1500 Kg	1200 Kg
Diametro mesa	1500 mm	1640 mm

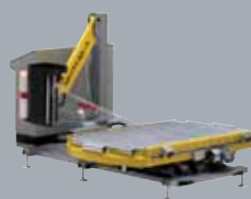
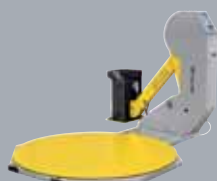
**MYTHO****REVOLUTION**

37 Impasse du Petit Prince

69124 Colombier Saugnieu

Tél: 04 78 32 66 70 / Fax: 04 72 93 23 20

Email: contact@bf-industries.fr

WWW.bf-industries.fr